

Article number: 20822856B

Description: E+G Mini indexing plunger
without rest position, GN 822.6-5-6-B

Measures

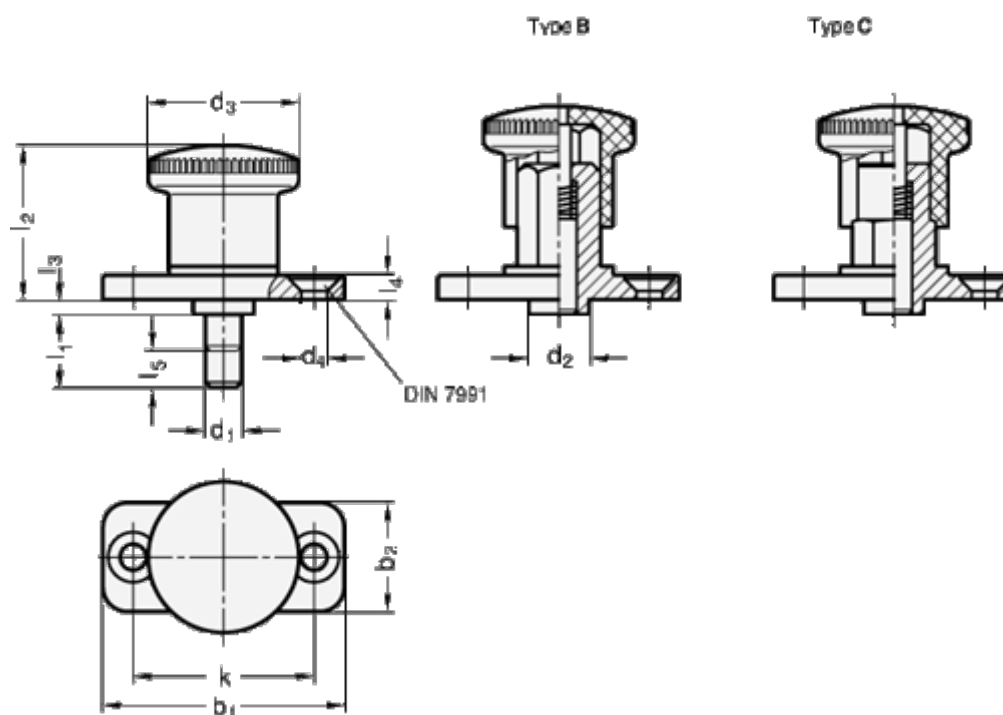

b1 = 40	l2	= 26
b2 = 18	l3	= 2.5
d1 = 5	l4	= 4
d2 = 10	l5	= 6
d3 = 25	Spring load initial N = 6	
d4 = 4.3		
k = 30		
l1 = 34.0		